

Serial-parallel Converter

ISP-A1C SERIES

It converts serial data and parallel input It transmits many I/O signal with a few signal cable

It is possible to make a wireless transmission with BWF

- It can transmit signals with 16 points max./unit for both input and output.
- It can extend up to 128 points max. by increasing units.
- It can make a high-speed transmission with 62.5kbps. (Only ISP-A1C)
- It can make a DIN-rail mounting with 35mm pitch.

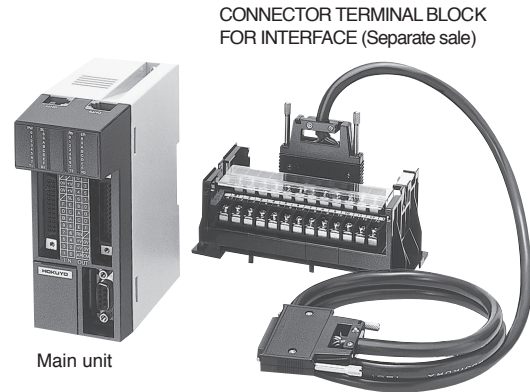

Specifications

Main and sub unit

Model No.		ISP-A1C	ISP-A1C-C
Connectable model No.		BWF series	CWF series
Power source		18V to 30VDC (Ripple 10% or less), 100mA (Except for photo-coupler interface)	
Current consumption		Input 85mA or less, Output 850mA or less	
Serial I/F	I/F type	Each 1 pce of RS-422 and RS-485 (Host communication: RS-422, local communication: RS-485)	
	Transmission method	Full-duplex two-way transmission	
	Transmission speed	62.5k/19.2k/9,600/4,800/2,400bps (Changeover)	19.2k/9,600/4,800/2,400bps(Changeover)
	Transmission distance	Host communication: 500m(Total length), Local communication: 2mMAX. (Between stations)	
Parallel I/F	Input signal numbers	16 points (It can extend up to 128 points by increasing units)	
	Input circuit	Photo-coupler input Input voltage: 18V to 30VDC (Using voltage is supplied from inside) Input current: 5mA/1 point, 85mA/1 unit	
	Output signal numbers	16 points (It can extend up to 128 points by increasing units) and 1 point (Alarmoutput)	
	Output circuit	Photo-coupler/open-collector output Load voltage: 18V to 30VDC (Using voltage is supplied from inside) Load current: 50mA/1 point, 850mA/1 unit	
Connection		Screw terminal only for power source, connector for other connections	
Ambient temperature/humidity		-10 to +50°C, 85%RH or less (not icing, not condensing)	
Case material		ABS resin (Cover: Polycarbonate)	
Weight		Approx. 260g	

Terminal box and others (Option)

Products	Remarks
Terminal box (1 pce)	Screw terminals with 24 pins
Cable for terminal box (1m)	For terminal box and with connector for I/O
Cable for terminal box (3m)	
Connector for I/O (1 set)	Only connector (Excluding cable)
D-sub connector for BWF/CWF	Use it when BWF/CWF series is applied (For host communication)
Cable for extension (150mm)	Cable for local communication between main unit and sub unit (With connector)
Cable for extension (300mm)	
Cable for extension (450mm)	

Input/Output circuit

Parallel input

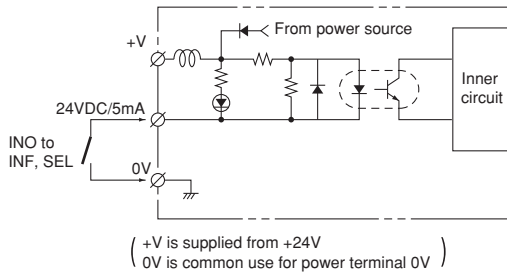

Parallel output

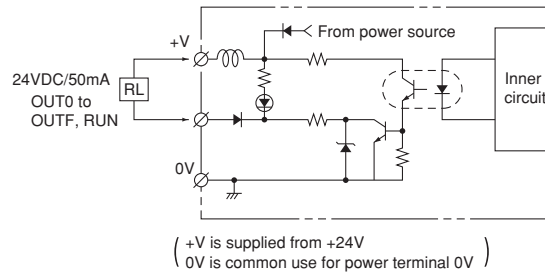

Serial input/output

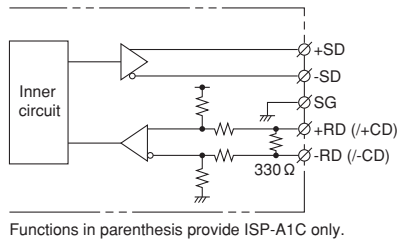

Warning output

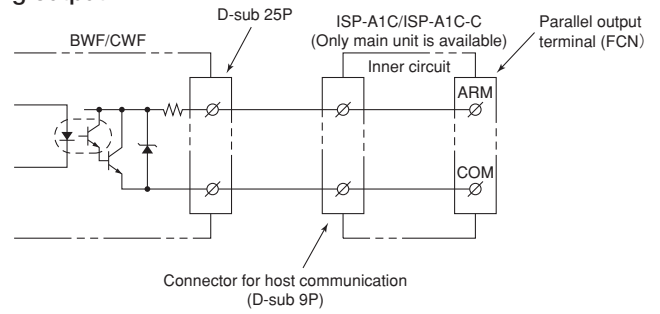

Connection

Parallel input

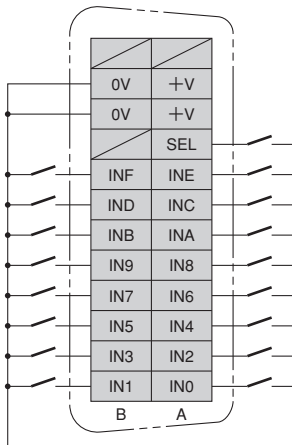

Parallel output

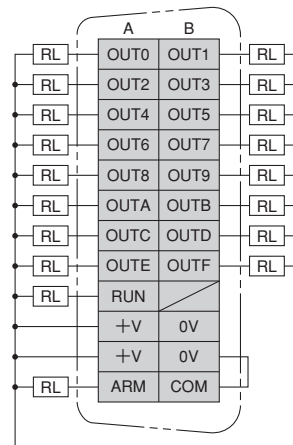

External dimensions

